

EN Instructions for Use for devices of type WM 090 TD



prisma SMART prisma SOFT

Sleep therapy devices



LÖWENSTEIN
medical

Contents

1	Introduction	4
1.1	Intended use	4
1.2	Description of function	4
1.3	User qualifications	4
1.4	Indications	4
1.5	Contraindications	5
1.6	Side effects	5
2	Safety	6
2.1	Safety information	6
2.2	General information	6
2.3	Warnings in this document	8
3	Product description	9
3.1	Overview	9
3.2	Operating states	10
3.3	Control panel	10
3.4	Symbols in the display	11
3.5	Accessories	12
4	Preparation and operation	13
4.1	Set up and connect the device	13
4.2	Start therapy	15
4.3	End therapy/switch off device	15
4.4	Set humidifier	15
4.5	Performing the mask test	16
4.6	Switch softSTART on and off	17
4.7	Use SD card (optional)	18
5	Menu settings	19
5.1	Function of the keys	19
5.2	Settings menu	19
5.3	Info menu/read out operating hours	21

6	Hygiene treatment	22
6.1	General information	22
6.2	Cleaning intervals	22
6.3	Hygiene treatment for device	23
6.4	Hygiene treatment for breathing tube	25
7	Function check	25
8	Troubleshooting	26
8.1	Device faults	26
8.2	Display messages	27
9	Servicing	28
10	Storage	28
11	Disposal	28
12	Appendix	29
12.1	Technical data	29
12.2	Marks and symbols	33
12.3	Scope of supply	35
12.4	Accessories and replacement parts	36
12.5	Warranty	36
12.6	Declaration of conformity	36

1 Introduction

1.1 Intended use

Devices of the WM 090 TD type are pressure-controlled, non-invasive, non-life-supporting therapy devices for treating sleep-related breathing disorders (SRBDs) using a mask. The devices are used on persons weighing 30 kg or more. CPAP mode can be used on persons aged 3 years upwards. The device may only be used on a physician's instructions. (auto)CPAP mode provides positive airway pressure for treating obstructive sleep apnea in patients who breathe spontaneously. Devices of the WM 090 TD type are used in clinical facilities and in the domestic environment. In the domestic environment, the devices also accompany the owner on trips away.

1.2 Description of function

A blower takes in ambient air through a filter and pumps it to the patient at therapy pressure through the patient circuit and the patient/ventilator interface. The user interface is for displaying and setting the available parameters. Therapy data are saved on the SD card and can be evaluated using PC software.

1.3 User qualifications

The person operating the device is referred to in these Instructions for Use as the user. A patient, on the other hand, is the person receiving the therapy.

As an owner/operator or user you must be familiar with the operation of this medical device. The owner/operator is responsible for ensuring the compatibility of the device and of all the components or accessories connected to the patient before use.

When the device is handed over to the patient, as the attending physician or medical specialist you must provide instruction in the function of the device.

1.4 Indications

prisma SOFT

CPAP therapy device for treating patients with obstructive sleep apnea with a constant pressure requirement.

prisma SMART

APAP therapy device for treating patients with obstructive sleep apnea with a variable pressure requirement. Therapy pressure adapts automatically to the patient's pressure requirement.

1.5 Contraindications

The following contraindications are known - in the individual case, responsibility for deciding whether to use the device rests with the attending physician. Threatening situations have not ever been observed.

Cardiac decompensation, severe cardiac arrhythmias, severe hypotension, especially in combination with intravascular volume depletion, severe epistaxis, high risk of barotrauma, severe lung disease (e.g. COPD), pneumothorax or pneumomediastinum, pneumocephalus, head injury, status following brain surgery and following surgical procedures on the hypophysis or middle or inner ear, acute inflammation of the nasal sinuses (sinusitis), middle ear infection (otitis media) or perforated eardrum, dehydration.

1.6 Side effects

When using the device, the following undesired side effects may occur in short-term or long-term use: pressure points from the mask and the forehead cushion on the face, reddening of the facial skin, dry throat, mouth, nose, feeling of pressure in the sinuses, irritated mucous membrane in the eyes, gastrointestinal insufflation of air ("bloating"), nosebleeds, reduced auditory capacity.

These are general side effects not attributable specifically to use of devices of the WM 090 TD type.

2 Safety

2.1 Safety information

2.1.1 Handling the device, the components and the accessories

If the device is damaged or its function is restricted, patients, users and people in the vicinity may be injured.

- ⇒ Only operate the device and its components if they are externally undamaged.
- ⇒ Perform a function check at regular intervals (see "7 Function check", page 25).
- ⇒ Only operate device within the specified ambient conditions (see "12.1 Technical data", page 29).
- ⇒ Do not reuse disposables. Disposables may be contaminated and/or their function may be impaired.
- ⇒ Water and dirt in the device may damage the device.
- ⇒ Only transport the device with the cover fitted.
- ⇒ Transport the device in the associated carrying bag.
- ⇒ Do not transport or tilt the device with the humidifier full.
- ⇒ Use the gray air filter.
- ⇒ Use the white pollen filter (optional accessory) if required.

2.1.2 Energy supply

Operating the device outside the specified energy supply may injure the user and damage the device.

- ⇒ Operate the device only with the power supply unit provided on voltages from 100 V to 240 V.
- ⇒ Use the DC adapter for operation on voltages of 12 V or 24 V.
- ⇒ Keep access to the power supply connector and the power supply free at all times.

2.1.3 Handling oxygen

Supplying oxygen without a special safety device can lead to fire and injure people.

- ⇒ Follow the Instructions for Use for the oxygen supply system.
- ⇒ Set up oxygen sources at a distance of over 1 m from the device.
- ⇒ At the end of therapy, shut off the oxygen supply and allow the device to run on briefly to flush residual oxygen out of the device.

2.2 General information



- The use of third-party articles may lead to incompatibility with the device. In such cases, please be aware that any claim under warranty and liability will be void if neither the accessories nor the genuine replacement parts recommended in the Instructions for Use are used.

- Have measures such as repairs, servicing and maintenance work carried out by the manufacturer or by specialists expressly so authorized by the manufacturer.
- Connect only the devices and modules permitted in accordance with these Instructions for Use. The devices must meet the product standard applicable to them. Non-medical equipment should be positioned away from the patient's vicinity.
- The device is subject to special precautions with regard to EMC (electromagnetic compatibility). Maintain the recommended safety distances (see "12.1.5 Safety distances", page 33) between the device and devices which emit high-frequency radiation (e.g. cellphones) to prevent malfunctions.
- In combination with the device itself, the use of tube heating will generate a slightly higher temperature at the patient connection opening.
- The operator is responsible for ensuring that the setting of the therapeutic pressure has been determined for each patient individually with the device configuration to be used.
- The operator should regularly assess the effectiveness of the therapeutic settings.
- To prevent infection or bacterial contamination, follow the section about hygiene treatment (see "6 Hygiene treatment", page 22).
- Keep therapy device and accessories away from children and pets. Store therapy device in transportation case when not in use or being transported.

2.3 Warnings in this document

Warnings indicate information relevant to safety.

Within procedures, you will find warnings in front of a step which contains a hazard to persons or objects.

 WARNING	<i>Warning!</i> Indicates an unusually significant hazardous situation. If you ignore this instruction, severe irreversible or fatal injuries may result.
 CAUTION	<i>Caution!</i> Indicates a hazard. If you do not follow this instruction, mild or moderate injuries may result
NOTICE	<i>Note!</i> Indicates a harmful situation. If you do not follow this instruction, material damage may result.
	Indicates useful information within procedures.

3 Product description

3.1 Overview

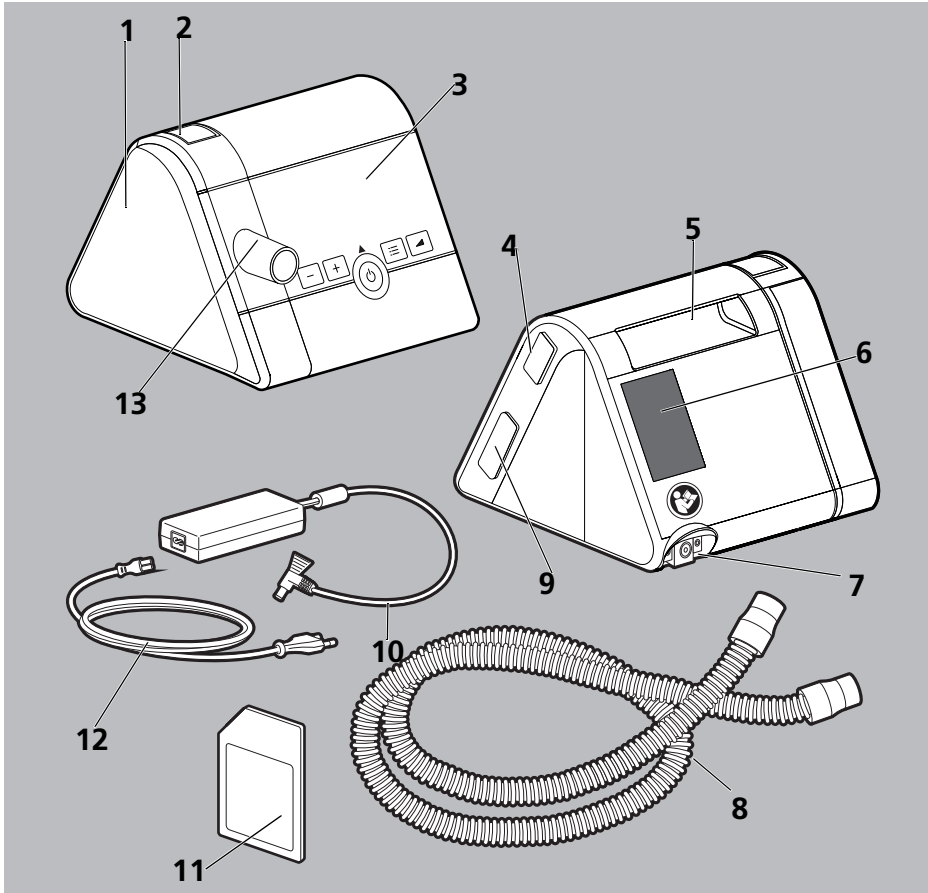

- 1 Humidifier connection with cover
- 2 Release catch
- 3 Control panel with display
- 4 Interface for connecting the communication module
- 5 Handle
- 6 Filter compartment
- 7 Connection for power supply cable
- 8 Breathing tube with connection for mask

- 9 SD card slot
- 10 Power supply unit
- 11 SD card
- 12 Power cord
- 13 Device outlet port

3.2 Operating states

- **On:** therapy is running.
- **Standby:** blower is off, but immediately operational if the On/off key is pressed briefly. Settings can be made on the device when it is in standby mode.
- **Off:** the device is de-energized. No settings can be made and the display remains dark.

















3.3 Control panel



- 1  key*
- 2  key*
- 3 On/Off key*
- 4 Menu key*
- 5 softSTART key*

* The keys of the device may have different functions. If there is a symbol above the key in the display, the key adopts the function of the symbol in question. If there is no symbol above the key, the key retains its original function.

3.4 Symbols in the display

SYMBOL	DESCRIPTION
	Orange symbol: expert area active. White symbol: parameters enabled for patient.
	Parameter is disabled for patient.
	Info menu
	Settings menu
	SoftSTART symbol
	Green symbol: SD card inserted. When the symbol is flashing, data are being written to the SD card.
	Orange symbol: SD card fault
	Leak display. Mask or tube leaking.
	White symbol: Humidifier connected.
	Green symbol: Humidifier switched on.
	Back to start screen
	Cancel
	Forward one menu item
	Back one menu item
	Confirms the current selection.
	Selection adopted successfully.

3.5 Accessories

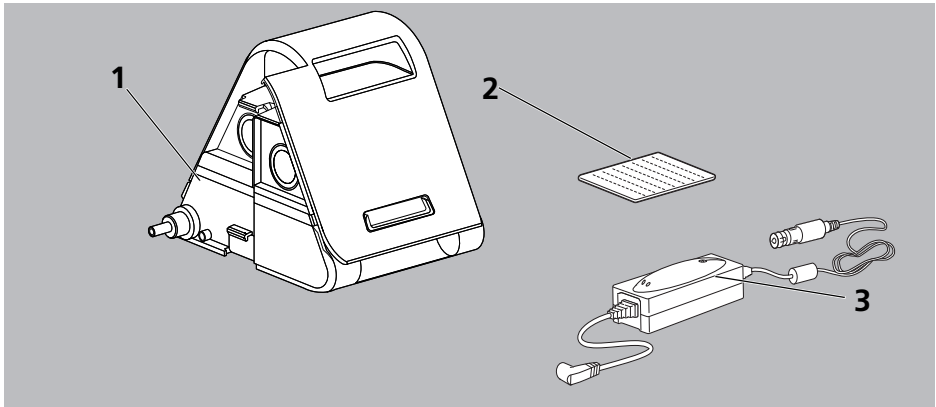

- 1 Humidifier
- 2 Pollen filter (white)
- 3 12-24 V DC adapter

4 Preparation and operation

4.1 Set up and connect the device

WARNING

Risk of injury due to contaminated or infected patient circuit!

A contaminated or infected patient circuit may transmit contamination or infections to the next patient.

- ⇒ Do not reprocess disposable patient circuits.
- ⇒ Subject reusable patient circuits to the correct hygiene treatment.

NOTICE

Material damage from overheating!

Excessive temperatures may lead to the device overheating and damage the device.

- ⇒ Do not cover device and power supply unit with textiles (e.g. bedclothes).
- ⇒ Do not operate device in the vicinity of a radiator.
- ⇒ Do not expose device to direct sunlight.
- ⇒ Do not operate device in the carrying bag.

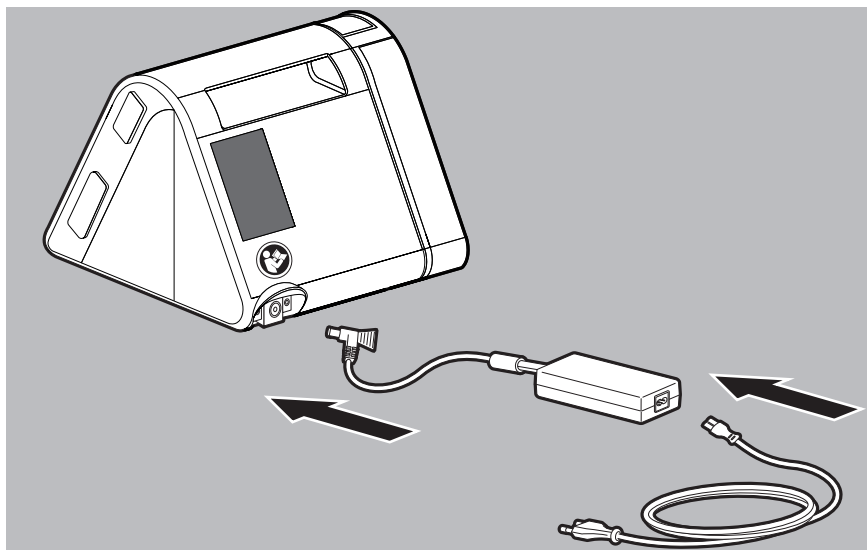

1. Connect the power supply unit to the device.

2. Connect the power cord to the power supply unit and the socket.
The operating hours of the device are displayed briefly. The device switches to standby.

⚠ CAUTION***Risk of injury if breathing tube routed incorrectly!***

An incorrectly routed breathing tube may injure the patient.

- ⇒ Never wrap the breathing tube around the neck.
- ⇒ Do not crush the breathing tube.

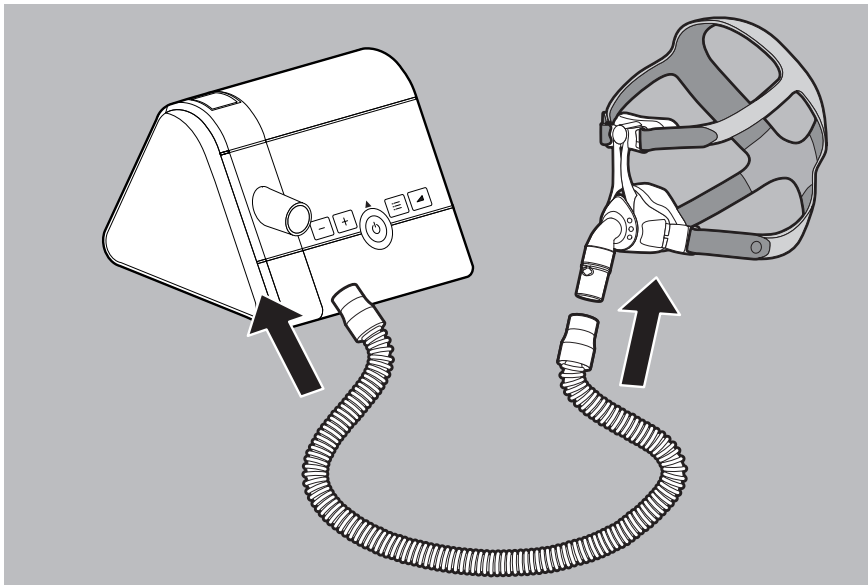

3. Push breathing tube onto the device outlet port.

 **WARNING**
Risk of suffocation if full-face masks without an exhalation system are used!

If full-face masks without an exhalation system are used, the CO₂ concentration may rise to critical values and put the patient at risk.

- ⇒ Use full-face masks with an external exhalation system if there is no integrated exhalation system.
- ⇒ Follow the Instructions for Use for the exhalation system.

4. Connect the mask to the breathing tube (see Instructions for Use for the breathing mask).



The proper position and arrangement of the mask on the face of the patient is critical for uniform use of the device.

4.2 Start therapy

Requirement

Device is set up and connected (see "4.1 Set up and connect the device", page 13).

1. If the display is dark: press any key briefly.
The device switches to standby.
2. Briefly press the On/off key .

or

If the autoSTART function is activated: breathe into the mask.
Current therapy pressure appears in the display. Therapy starts.



For more information on autoSTART (see "5 Menu settings", page 19).

4.3 End therapy/switch off device

1. Briefly press the On/off key .

or

If the autoSTART function is activated: remove mask.

The device displays the therapy hours for the current day and then switches to standby.







To save energy, you can disconnect the plug from the socket during the day.

4.4 Set humidifier

Requirement

Humidifier is connected and filled with water (see Instructions for Use for humidifier).
The humidifier symbol  can be seen in the display.

1. Start therapy (see "4.2 Start therapy", page 15).
The humidifier switches on automatically. The humidifier symbol goes green .
2. To increase the humidifier stage: press the  key.
3. To decrease the humidifier stage: press the  key.
4. To switch off the humidifier: press the  key until  appears in the display.
 - The humidifier stage suitable for you depends on room temperature and humidity. If you have dry airways in the morning, heating output is set too low. If condensation has formed in the breathing tube in the morning, heating output is set too high.
 - When the water level in the humidifier is too low, the device switches off the humidifier automatically.
 - If the humidifier symbol is flashing, you need to fill the humidifier with water (see Instructions for Use for humidifier).







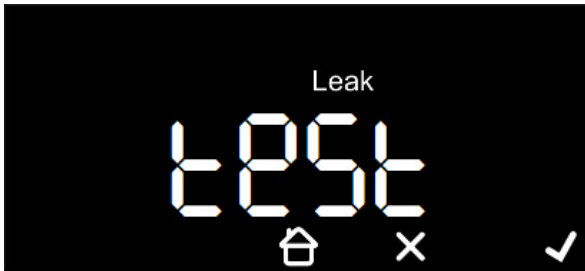

4.5 Performing the mask test

Requirement: Therapy is running.

1. Press menu button .



2. To start the mask test: Press .
- The remaining time and the mask test pressure are displayed.
3. If necessary: Press  or  button to change the mask test pressure.
4. Check mask for leaks.
 - Proper mask location: Green  checkmark.
 - Mediocre mask location: Leakage display  turns orange.
 - Poor mask location: Leakage display  flashes.
5. If necessary: Adjust mask.
6. Wait until the device has completed the mask test.
 - or**
 - Press .

4.6 Switch softSTART on and off

Requirement

Therapy is running. softSTART is activated by the physician.

If the soft start is activated, the device automatically turns on every time therapy is started.

1. Press the softSTART key  briefly to switch on softSTART manually.



Remaining time and the current softSTART pressure are displayed.

2. Press the softSTART key  briefly to switch off softSTART.



- If you press the softSTART key  when the device is on standby, the device switches to the patient menu and you can adjust the softSTART time (see "5.2 Settings menu", page 19).
- To deactivate softSTART, set the softSTART time to **OFF**

4.7 Use SD card (optional)

If an SD card is present, the device automatically saves the therapy data to the SD card. An SD card is not required to operate the device.

Requirement

The device is on standby.



NOTICE

Loss of data if power is interrupted!

If the device is disconnected from the power supply during the save process, data may be lost.

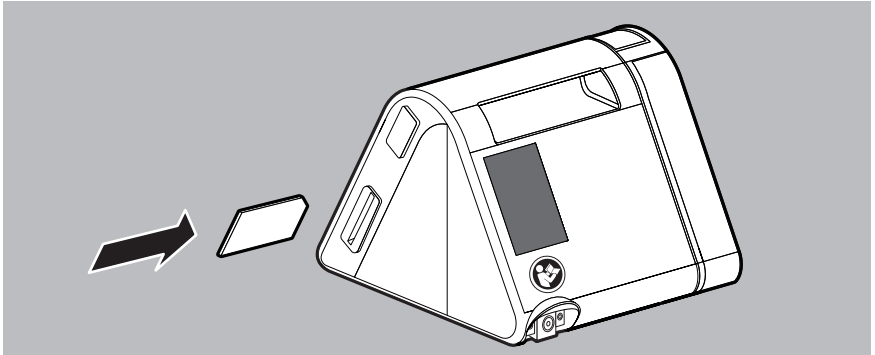
- ⇒ Leave the device connected to the power supply during the save process (SD card symbol  flashing).



1. Push the SD card into the SD card slot until you hear it engage. The SD card symbol  appears in the display.
2. To remove it, press the SD card briefly and remove the SD card. In doing so, please note: do not remove the SD card while the SD card symbol  is flashing.

5 Menu settings

5.1 Function of the keys



The keys of the device may have different functions. If there is a symbol above the key in the display (e.g. ✓ above the softSTART key), the key adopts the function of the symbol in question. If there is no symbol above the key (e.g. in the case of the + key), the key retains its original function.

5.2 Settings menu

5.2.1 Navigate in the menu







Requirement

The device is on standby.

1. Press the menu key



2. To call up the settings menu: press
3. Make settings in the menu.

FUNCTION KEY	DESCRIPTION
	Scroll forward through menu
	Scroll back through menu
	Increase value
	Reduce value
	Confirm value
	Discard value
	Exit menu. Switch back to start screen.

5.2.2 Menu structure

You can set the following parameters if your physician has enabled them for you.

PARAMETER	DESCRIPTION
softSTART (t)	Here you can set the time for which ventilation pressure rises to therapy pressure during the softSTART. If this function cannot be selected, it needs to be enabled by the physician or specialist dealer.
autoSTART	If autoSTART is activated (On), the device can be switched on by a breath (> 0.5 hPa) being taken into the mask and switches off automatically after 5 seconds without a breath being taken. Switch autoSTART to OFF to switch off this function.
softPAP	The device temporarily reduces therapy pressure in stages 1 and 2 before the transition to exhalation. softPAP breathing relief is suitable for patients who find it unpleasant to exhale against a high pressure. Switch softPAP to OFF to deactivate this function.
Time	You can set the current time here.
Format time display	Here you can set whether the time is to be displayed in the form 0-24 (24-h clock) or 0-12 (12-h clock).



5.3 Info menu/read out operating hours

Requirement

The device is on standby.

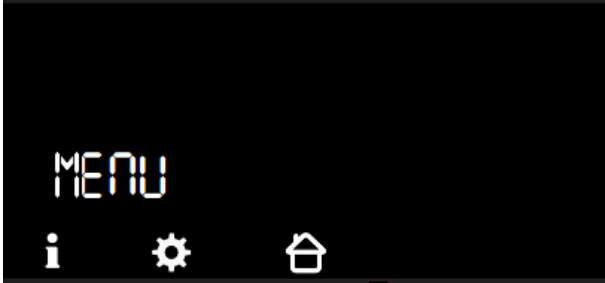
1. Press the menu key .



2. To call up the info menu: press .
3. Navigate to the desired value with the  or  keys:

DISPLAY	MEANING
0000 h	Total operating hours of the device
1 d	Operating hours for the last day.
7 d	Operating hours for the last 7 days.
28 d	Operating hours for the last 28 days.
182 d	Operating hours for the last 182 days.
366 d	Operating hours for the last 366 days.



- Data are displayed only if they really are present in the device.
- Each therapy day begins and ends at 12 noon. Data recorded from midnight to 12 noon are assigned to the previous calendar day.

6 Hygiene treatment

WARNING

Risk of infection when the device is used again!

If the device is used by several patients, infections may be transmitted to the next patient.

⇒ If the device is used again: have the device subjected to a hygiene treatment by the manufacturer or an authorized specialist dealer.

6.1 General information

- Wear appropriate safety gear for the disinfecting process.
- Refer to the Instructions for Use for the disinfectant used.
- Following a hygiene treatment by the authorized specialist dealer, the device is suitable for using again with other patients.

6.2 Cleaning intervals

INTERVAL	ACTION
Weekly	Clean device (see "6.3 Hygiene treatment for device", page 23)
	Clean breathing tube (see "6.4 Hygiene treatment for breathing tube", page 25)
Monthly	Clean air filter (see "6.3.1 Clean air filter (gray filter)", page 24)
	Replace pollen filter (see "6.3.2 Replace optional pollen filter (white filter)", page 24)
Every 6 months	Replace air filter
Annually	Replace breathing tube
As required	In the clinical sphere: disinfect breathing tube (see "6.4 Hygiene treatment for breathing tube", page 25)
On change of patient	Have specialist dealer perform a hygiene treatment on the device before using it again.

6.3 Hygiene treatment for device

 **CAUTION**

Risk of injury from electric shock!

Ingress of liquids may lead to a short-circuit, injure the user and damage the device.

- ⇒ Disconnect the device from the power supply before the hygiene treatment.
- ⇒ Do not immerse the device and components in liquids.
- ⇒ Do not pour liquids over the device and components.

1. Subject the device and components to a hygiene treatment in accordance with the table below.

PART	CLEANING	DISINFECTING	STERILIZATION
Housing including device outlet port/inlet	Wipe down: use water or mild detergent	Disinfect by wiping (recommended products: terralin® protect or perform advanced Alcohol EP)	Not permitted
High-gloss surfaces on the housing	Wipe down: use water or mild detergent; do not use microfiber cloths		
Power cord and power supply unit	Wipe down: use water or mild detergent		

2. Replace mask, breathing tube, air filter and pollen filter (if present).
3. Perform function check ([see "7 Function check", page 25](#)).

6.3.1 Clean air filter (gray filter)

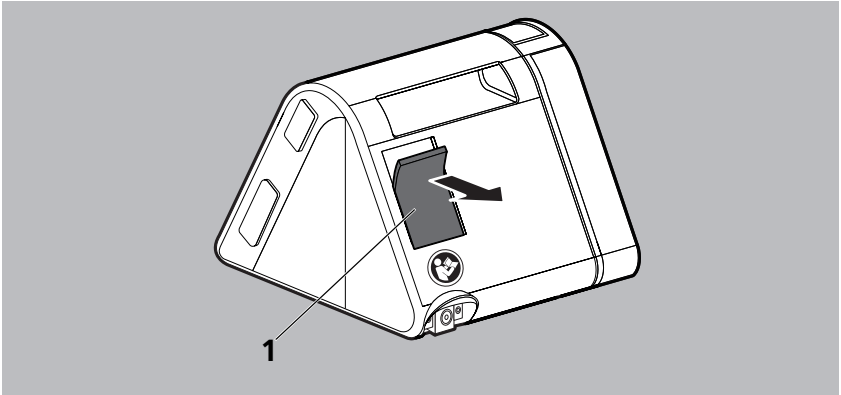

1. Clean air filter **1** under running water.
2. Allow air filter **1** to dry.

6.3.2 Replace optional pollen filter (white filter)

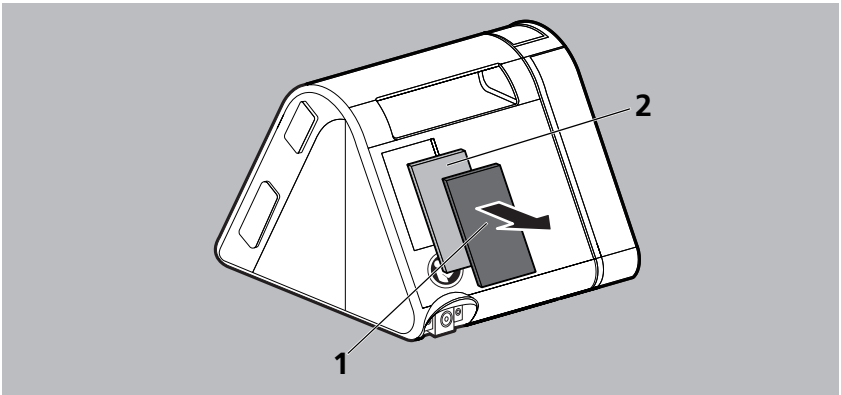

1. Remove air filter **1**.
2. Replace white pollen filter **2**.
3. Replace air filter **1** in the holder.

6.4 Hygiene treatment for breathing tube

NOTICE

Risk of material damage as a result of ingress of liquids!

The device may be damaged by the ingress of liquids.

⇒ Use the breathing tube only when completely dry.

1. Subject the breathing tube to a hygiene treatment in accordance with the table below.

CLEANING	DISINFECTING	STERILIZATION
With hot water and detergent	Disinfect by immersion (Recommended product: gigasept FF®)	Not permitted

2. Rinse off breathing tube with clean water and shake thoroughly.
3. Dry breathing tube.



If you use a heated breathing tube, see the Instructions for Use for the breathing tube.

7 Function check

Carry out a function check after each hygiene treatment and maintenance task, but at least every 6 months.

1. Check device for external damage.
2. Check connectors and cables for external damage.
3. Check that components are correctly connected to the device.
4. Connect device to the power supply and switch it on (see "4.1 Set up and connect the device", page 13).
5. If softSTART is active: press softSTART key  to cancel softSTART.
6. Close the opening of the breathing mask.
7. Compare the pressure shown in the display with the prescribed pressure.
8. If one of the items is not OK or pressure deviates by > 1 hPa: do not use device and contact your specialist dealer.

8 Troubleshooting

If you are unable to remedy faults with the aid of the table, or in the event of unexpected operation or an incident, contact the manufacturer or your authorized specialist dealer. To avoid exacerbating the damage, do not continue operating the device.

You can find an explanation of the symbols which may appear in the display in the product description (see "3.4 Symbols in the display", page 11).

8.1 Device faults

FAULT/FAULT MESSAGE	CAUSE	REMEDY
No running noise, nothing in the display.	No power supply.	Check that the power cord is securely connected. Check function of socket.
Therapy cannot be started by taking a breath.	autoSTART function not activated.	Activate autoSTART function.
Device does not switch off after approx. 5 seconds once mask is removed.	autoSTART function may be restricted in the case of accessories with a high resistance.	Contact your specialist dealer.
softSTART cannot be switched on.	softSTART function is disabled.	Ask the physician whether the function can be enabled.
Device does not reach the set target pressure.	Air filter dirty.	Clean air filter. If necessary: replace filter (see "6 Hygiene treatment", page 22).
	Breathing mask leaking.	Adjust headgear so that the mask is tight. If necessary, replace faulty mask.

8.2 Display messages

If the message **Err (xxx)** appears in the display, look in the table for the error code displayed. Remedy the error in accordance with the description.

ERROR CODE	CAUSE	REMEDY
(108)	Device has lost the saved time.	Contact specialist dealer and have device repaired.
(204)	Humidifier not working properly.	Remove humidifier from device and re-connect it. If the message continues to be displayed, contact an authorized specialist dealer and have the device and the humidifier checked.
(601), (610) or (609)	Faulty SD card	Remove and reinsert SD card. If the message persists, replace the SD card.
(603)	SD card full	Delete data from the SD card/Use new SD card.
(701)	Leak on humidifier or at the cover on the side	Remove humidifier or side cover from device and re-connect. If the message continues to be displayed, contact an authorized specialist dealer and have the device and the humidifier checked.
All other error codes	Electronics problems	Disconnect the device from the power supply and reconnect it (see 4.1, p.13). If the message continues to be displayed, contact an authorized specialist dealer and have the device and the humidifier checked.

9 Servicing

The device is designed for a service life of 6 years.

If used in accordance with the intended use, the device requires no servicing during this period.

If the device is used beyond this period, it needs checking by an authorized specialist dealer.

10 Storage

Store the device under the specified ambient conditions. Clean the device before storing it.

11 Disposal



Do not dispose of the product or any rechargeable batteries with domestic waste. To dispose of properly, contact a licensed, certified electronic scrap disposal merchant. This address is available from your Environment Officer or from your local authority.

The device packaging (cardboard and inserts) can be disposed of in paper recycling facilities.

12 Appendix

12.1 Technical data

12.1.1 Device

SPECIFICATION	DEVICE
Product class to 93/42/EEC	IIa
Dimensions W x H x D in cm	17 x 13.5 x 18
Weight	1.34 kg
Temperature range - operation - storage	+5 °C to +40 °C -25 °C to +70 °C
Rel. humidity, non-condensing for - operation - storage	10% to 93% 10% to 95%
Air pressure range	700 hPa to 1060 hPa, corresponds to an altitude of 3000 m above mean sea level
Connection diameter of breathing tube in mm	19.5 (fits standard tapered connector)
Power capacity	Max. 40 VA
System interface	24 V DC Max. 5 VA
Current consumption in operation (therapy) 230 V 115 V	0.13 A 0.22 A
on standby 230 V 115 V	0.036 A 0.053 A
Classification to DIN EN 60601-1-11: class of protection against electric shock	Protection class II
degree of protection against electric shock	Type BF
protection against damaging ingress of water and solids	IP21

SPECIFICATION	DEVICE	
Classification to DIN EN 60601-1: duty cycle	Continuous duty	
Application part	Breathing mask	
Electromagnetic compatibility (EMC) to DIN EN 60601-1-2 Radio interference suppression Radio interference immunity	Test parameters and limit values can be obtained from the manufacturer on request. EN 55011 B IEC 61000-4 Parts 2 to 6, Part 11, Part 8 IEC 61000-3 Parts 2 and 3	
Mean sound pressure level/ operation to ISO 80601-2-70	approx. 26 dB(A) at 10 hPa (corresponds to a sound power level of 34 dB(A))	
Mean sound pressure level/ operation to ISO 80601-2-70 with humidifier	approx. 27.5 dB(A) at 10 hPa (corresponds to a sound power level of 35.5 dB(A))	
CPAP operating pressure range	4 hPa to 20 hPa	
Pressure accuracy	0.5 hPa \pm 3% of the measured value	
P lim _{max} (maximum pressure in the event of a fault)	\leq 40 hPa	
Maximum flow rate to ISO 80601-2-70 Test pressures: 4 hPa 8 hPa 12 hPa 16 hPa 20 hPa	Pressure measured at the patient connection opening at a flow rate of 40 l/min	Mean flow rate prevailing at the patient connection opening
	3.9 hPa 7.8 hPa 11.8 hPa 15.8 hPa 19.7 hPa	160 l/min* 155 l/min* 130 l/min* 130 l/min* 115 l/min**
	At an ambient pressure of 700 hPa, the values drop by * -10 % ** - 50 %	
Heating of respiratory air	Max. +3 °C	
Stability of dynamic pressure (short-term precision) at 10 breaths/min to ISO 80601-2-70 at 4 hPa 8 hPa 12 hPa 16 hPa 20 hPa	With breathing tube, with humidifier	With breathing tube, without humidifier
	$\Delta p \leq 0.3$ hPa $\Delta p \leq 0.4$ hPa $\Delta p \leq 0.6$ hPa $\Delta p \leq 0.5$ hPa $\Delta p \leq 0.7$ hPa	$\Delta p \leq 0.3$ hPa $\Delta p \leq 0.4$ hPa $\Delta p \leq 0.4$ hPa $\Delta p \leq 0.5$ hPa $\Delta p \leq 0.6$ hPa

SPECIFICATION	DEVICE	
Stability of dynamic pressure (short-term precision) at 15 breaths/min to ISO 80601-2-70 at 4 hPa 8 hPa 12 hPa 16 hPa 20 hPa	With breathing tube, with humidifier $\Delta p \leq 0.4$ hPa $\Delta p \leq 0.5$ hPa $\Delta p \leq 0.6$ hPa $\Delta p \leq 0.8$ hPa $\Delta p \leq 0.8$ hPa	With breathing tube, without humidifier $\Delta p \leq 0.4$ hPa $\Delta p \leq 0.5$ hPa $\Delta p \leq 0.6$ hPa $\Delta p \leq 0.7$ hPa $\Delta p \leq 0.8$ hPa
Stability of dynamic pressure (short-term precision) at 20 breaths/min to ISO 80601-2-70 at 4 hPa 8 hPa 12 hPa 16 hPa 20 hPa	With breathing tube, with humidifier $\Delta p \leq 0.6$ hPa $\Delta p \leq 0.7$ hPa $\Delta p \leq 0.8$ hPa $\Delta p \leq 1.0$ hPa $\Delta p \leq 1.1$ hPa*	With breathing tube, without humidifier $\Delta p \leq 0.6$ hPa $\Delta p \leq 0.8$ hPa $\Delta p \leq 0.8$ hPa $\Delta p \leq 1.0$ hPa $\Delta p \leq 0.9$ hPa*
	*At 700 hPa ambient pressure $\Delta p \leq 1.6$ hPa	
Stability of static pressure (long-term precision) to ISO 80601-2-70	$\Delta p < 0.25$ hPa	
Recommended maximum additional oxygen flow rate	15 l/min	
Pollen filter up to 1 μm up to 0.3 μm	Filter class E10 ≥ 99.5 % ≥ 85 %	
Service life of pollen filter	approx. 250 h	
SD card	Memory size 2 GB to 32 GB can be used, interface compatible with SD physical layer version 2.0	

TOLERANCES FOR MEASURED VALUES

Pressure:	± 0.75 % from measured value or ± 0.1 hPa
Flow rate:	± 2 % from actual value
Temperature:	± 0.3 °C
Noise pressure level and noise power level	± 2 dB(A)

The right to make design modifications is reserved.

All flow rate and volume values determined under STPD conditions.

All parts of the device are free from latex.

Devices of the WM 090 TD type use the following open-source software:
FreeRTOS.org

The software of this device contains code which is subject to the GPL. You can see the GPL source code and the GPL on request.

12.1.2 Technical data for power supply unit

SPECIFICATION	POWER SUPPLY UNIT
Maximum output capacity	60 W
Input voltage	100 V - 240 V
Frequency	47 Hz - 63 Hz

12.1.3 Pressure/volume curve

p/V curve at $AV = 0.5$ l and $f = 20/\text{min}$

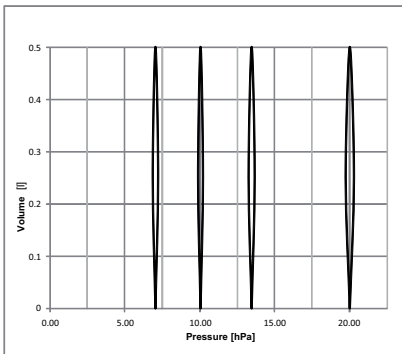

12.1.4 Pneumatic diagram

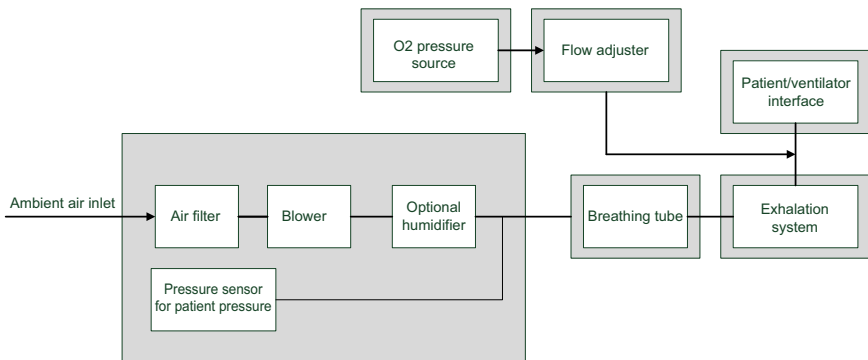

12.1.5 Safety distances

RECOMMENDED SAFETY DISTANCES BETWEEN PORTABLE AND MOBILE HF TELECOMMUNICATION DEVICES (E.G. CELLPHONES) AND THE DEVICE



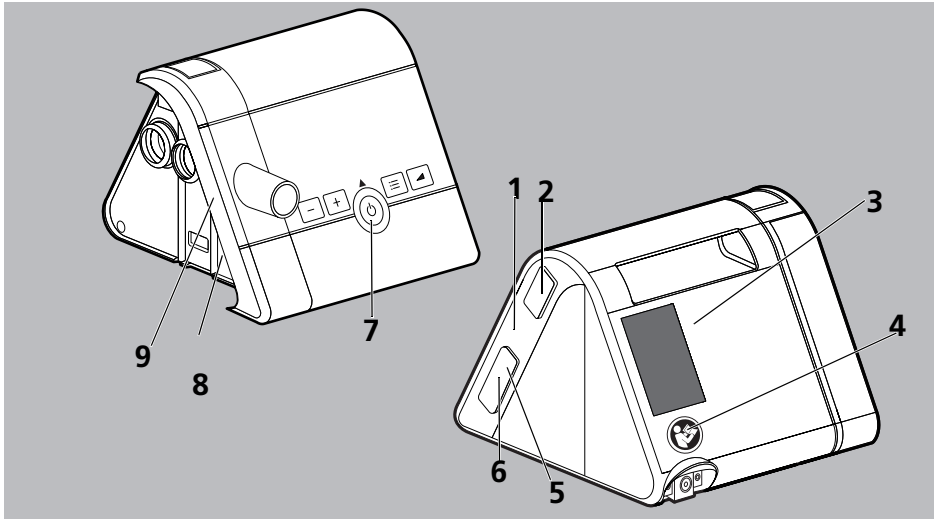

Nominal capacity of HF device in W	Safety distance depending on transmission frequency in m			
	150 kHz - 80 MHz outside ISM bands	150 kHz - 80 MHz within ISM bands	80 MHz - 800 MHz	800 MHz - 2.5 GHz
0.01	0.04	0.12	0.12	0.23
0.1	0.11	0.38	0.38	0.73
1	0.35	1.20	1.20	2.30
10	1.10	3.80	3.80	7.27
100	3.50	12.00	12.00	23.00

12.2 Marks and symbols





12.2.1 Markings on the device







NO.	SYMBOL	DESCRIPTION
1	SN	Serial number of the device
		Year of manufacture
2, 8		Follow Instructions for Use
3		Device inlet: ambient air inlet

NO.	SYMBOL	DESCRIPTION
4		Follow Instructions for Use
5		Slot for the SD card
6		USB connection (optional)
7		On/off: indicates the On/off key



DEVICE ID PLATE ON THE BOTTOM OF THE DEVICE

TYP	Type designation of the device
IP21	Degree of protection against solid foreign bodies. Device is protected against drips.
	Degree of protection against electric shock: protection class II device
	Do not dispose of device in domestic waste.
	Suitable for use in aircraft. Meets RTCA/DO-160G Section 21, Category M.
	Application part type BF
	Manufacturer
CE 0197	CE symbol (confirms that the product conforms to the applicable European directives)

12.2.2 Markings on the device ID plate of the power supply unit

SYMBOL	DESCRIPTION
INPUT	Input voltage
OUTPUT: 	Output voltage/direct voltage
	Only intended for indoor use.
	Degree of protection against electric shock: protection class II device
	Do not dispose of device in domestic waste.
	CE symbol (confirms that the product conforms to the applicable European directives)

12.2.3 Markings on the packaging of the device and accessories

SYMBOL	DESCRIPTION
	Permitted storage temperature: -25 °C to +70 °C
	Permitted humidity for storage: 10 % to 95 % relative humidity
	Use only for a single patient

12.3 Scope of supply

A current list of scopes of supply can be ordered on the website of the manufacturer or through your specialist dealer.

The parts below are included in the standard scope of supply.

PART	ITEM NUMBER
Basic device	Varies depending on device variant
Breathing tube	WM 24445
Power cord	WM 24133
Power supply unit	WM 24480
Set, 2 air filters	WM 29928
SD card	WM 29794
Instructions for Use	WM 68201

12.4 Accessories and replacement parts

A current list of accessories and replacement parts can be ordered on the internet site of the manufacturer or through your authorized specialist dealer.

12.5 Warranty

Löwenstein Medical gives the customer a limited manufacturer warranty on a new original Löwenstein Medical product and on any replacement part fitted by Löwenstein Medical in accordance with the warranty conditions applicable to the product in question and in accordance with the warranty periods from date of purchase listed below. The warranty conditions are available on the website of the manufacturer. We will also send you the warranty conditions on request. In the event of a claim under warranty, contact your specialist dealer.

PRODUCT	WARRANTY PERIODS
Löwenstein Medical devices including accessories (except masks) for sleep diagnosis, home ventilation, oxygen medicine and emergency medicine	2 years
Masks including accessories, rechargeable batteries, batteries (unless quoted differently in the technical documentation), sensors, patient circuits	6 months
Disposable products	None

12.6 Declaration of conformity

Löwenstein Medical Technology GmbH + Co. KG, Kronsaalsweg 40, 22525 Hamburg, Germany, the manufacturer of the devices described in these Instructions for Use, hereby declares that the product complies with the relevant regulations of the Medical Device Directive 93/42/EEC. The unabridged text of the Declaration of Conformity can be found on the manufacturer's website.

CE 0197

**Löwenstein Medical
Technology GmbH + Co. KG**
Kronsaalsweg 40
22525 Hamburg, Germany
T: +49 40 54702-0
F: +49 40 54702-461
www.loewensteinmedical.de



gba10393en1605

